

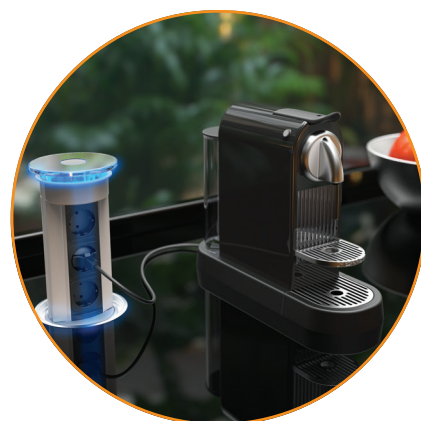

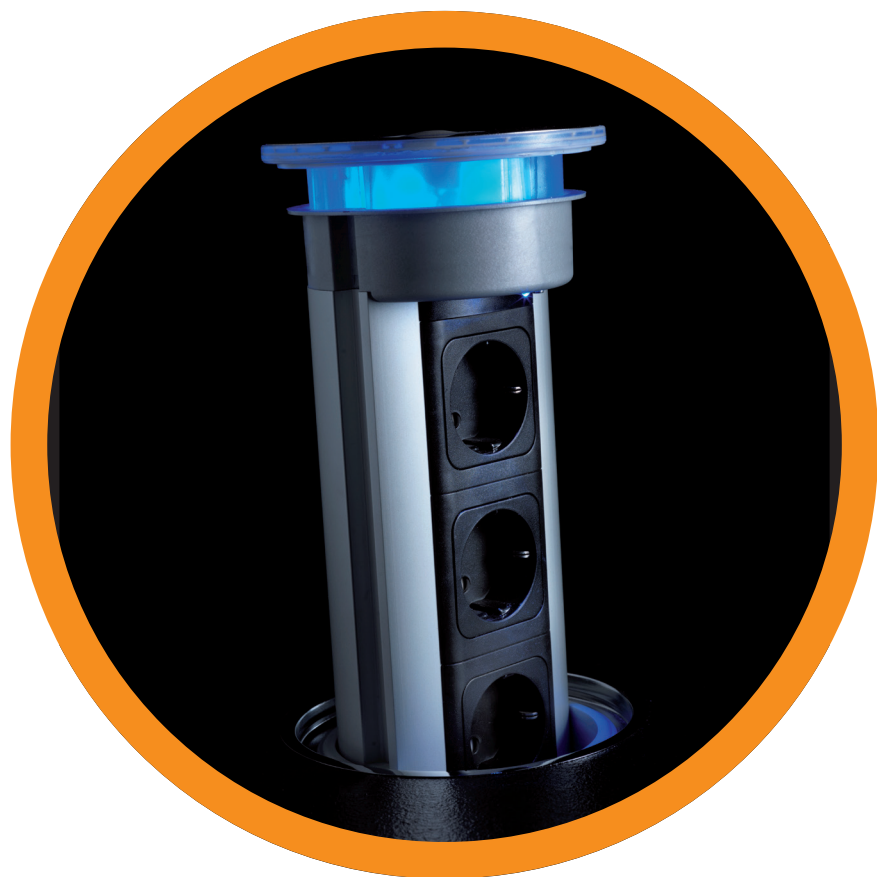









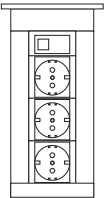

TORRETTE A SCOMPARSA CONCEALED POWERDOCK

versalux

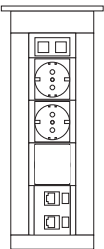
torretta estraibile Delux
Deluxe concealed powerdock



| Versalux | | | | | | |
|-----------------------------------------------------|-------------------------------------------------------------------------------|-------------------------------------------------------------------------------------------------------------------------------------------------------------------------|---------------------------------------------------------------------------------------------------------------------------------------------------------------------|---------------------------------------------------------------------------------------------------------------------------------------------------------------------|-------------------------------------------------------------------------------------------------------------------------------------------------------------------------|-------------------------------------------------------------------------------------------------|
| PRESA SOCKET | |   |   |   |   | |
| | | U (UNEL) | F (SCHUKO) | E (FRENCH) | G (UK) | |
| | | 3 FRUTTI POWER + 1 USB 5V (2 PORTE A+A) + 1 LED BLU 3 POWER SOCKETS + 1 USB 5V (2 PORTS A+A)+ 1 LED BLUE | | | | |
| CODICE CODE | Profilo Alluminio, Tappo Acciaio Inox / Aluminum Profile, Inox Cover | 060.13U.00001 | 060.13F.00001 | 060.13E.00001 | 060.13G.00001 |  L = 323 mm |
| | | | | | | |
| | Profilo cromo, Tappo cromo / Chrome profile, Chrome cover | 060.13U.00002 | 060.13F.00002 | 060.13E.00002 | 060.13G.00002 | |
| NOTE NOTE | DIM. L x H x W 50 x 21 x 18 cm |  | PESO WEIGHT 1,75 kg | CODICE DOGANALE CUSTOM CODE 85366990 | N° PZ PER SCATOLA PCS PER BOX 1 | MOQ 4 pz / pcs |
| | | 2 FRUTTI POWER + 1 USB 5V (2 PORTE A+A) + 2 RJ45 + 1 LED BLU 2 POWER SOCKETS + 1 USB 5V (2 PORT A+A) + 2 RJ45 + 1 LED BLUE | | | | |
| CODICE CODE | Profilo Alluminio, Tappo Acciaio Inox / Aluminum Profile, Inox Cover | 060.13U.00003 | 060.13F.00003 | 060.13E.00003 | 060.13G.00003 |  L = 323 mm |
| | | | | | | |
| | Profilo cromo, Tappo cromo / Chrome profile, Chrome cover | 060.13U.00004 | 060.13F.00004 | 060.13E.00004 | 060.13G.00004 | |
| NOTE NOTE | DIM. L x H x W 50 x 21 x 18 cm |  | PESO WEIGHT 2 kg | CODICE DOGANALE CUSTOM CODE 85366990 | N° PZ PER SCATOLA PCS PER BOX 1 | MOQ 4 pz / pcs |
| NOTE NOTES | | | | | | |
| CAVI INCLUSI CABLES INCLUDED 2 metri / meters | |   | | | | |

VersaLux

Torretta estraibile deluxe
Deluxe concealed power dock

Versalux è una torretta di connessione elettrica predisposta con una illuminazione superiore a led, pensata anche come luce di cortesia. Il suo sistema a scomparsa rappresenta una soluzione tecnologica di alto livello e ne consente l'utilizzo solo all'occorrenza. Adatta a piani cucina, direzionali, postazioni operative e piani di servizio.

Versalux is a power supply tower designed with a blue led light, useful also as courtesy light. The VersaLux module embraces a high standard of technological development, with a concealed system bringing electric to kitchen worktops, executive desks and workstations. Expose the sockets as and when required and then push it down freeing up workspace.



Dati commerciali / Commercial data

Codice prodotto/Product code:

N° Disegno/ Drawing N°:

VersaLux

Dati tecnici/Technical data

Generale/General

| | | |
|------------------------------------------------------|--------------------------|-----------------------------------------------------------------|
| Tensione nominale <i>Rated voltage</i> | 110 - 250 V ac, 50/60 Hz | |
| Corrente nominale <i>Rated current</i> | 10 - 16A | |
| Carico massimo complessivo <i>Max.load power</i> | 3400W | Per prese tipo / <i>For sockets type</i> : E - F - K - L - UNEL |
| | 2800W | Per prese tipo / <i>For sockets type</i> : G |
| | 2200W | Per prese tipo / <i>For sockets type</i> : I - J |
| | 1200W | Per prese tipo / <i>For sockets type</i> : B |
| Grado di protezione <i>Degree of protection</i> | IP20 | |
| Ambiente di utilizzo <i>Operating environment</i> | Interno <i>Indoor</i> | |

Materiali/Materials

| | |
|------------------------------------------------------------------------|-----------------------------------------------------------------|
| Profilo <i>Profile</i> | Alluminio <i>Aluminium</i> |
| Coperchio ed elementi di fissaggio <i>Cover and fixing elements</i> | Tecnopolimero autoestinguente <i>Flame retardant polymer</i> |
| Prese elettriche <i>Electric Sockets</i> | Tecnopolimero autoestinguente <i>Flame retardant polymer</i> |

Prese elettriche/ Electric sockets

| | | |
|----------------------------------|---------------------------------------------------------------------------------------------------------------------------------------------------------------------|-------------------------------------------------------------------|
| Tipo <i>Type</i> | B - E - F - G - I - J - K - L - UNEL, 2P+T, con otturatori (protezione bimbi) <i>B - E - F - G - I - J - K - L - UNEL, 2P+T, with shutters(child protection)</i> | |
| |  | |
| Vtaggio <i>Rated voltage</i> | 220 - 250 V ac 50 Hz | Preso tipo/ <i>Socket type</i> : E - F - G - I - J - K - L - UNEL |
| | 110 - 125 V ac 60 Hz | Preso tipo/ <i>Socket type</i> : B |
| Corrente <i>Rated current</i> | 16 A | Preso tipo/ <i>Socket type</i> : E - F - K - L - UNEL |
| | 15 A | Preso tipo/ <i>Socket type</i> : B |
| | 13 A | Preso tipo/ <i>Socket type</i> : G |
| | 10 A | Preso tipo/ <i>Socket type</i> : I - J |

Porte USB da ricarica / USB Charging ports

| | | |
|----------------------------|------------------------------------------------------|--------------------------------------------------------------------------------------------------------------------------------------------------------------------------|
| Ingresso: <i>Input:</i> | Ingresso tensione AC: <i>Input AC voltage:</i> | 100 - 250 V ac 50/60 Hz |
| | Uscita DC - porta USB <i>Output DC - USB port</i> | 5V - 2.1A |
| Uscita: <i>Output:</i> | Potenza totale <i>Total output power</i> | 10.5 W |
| | Tipo connettore USB <i>USB connector type</i> | Tipo A femmina <i>Type A female</i> |
| | Compatibilità <i>Compatibility</i> | Tutti smartphone, tablet e dispositivi ricaricabili (fotocamere, auricolari, ecc.) <i>All smartphones, tablets and USB chargeable devices (cameras, headset etc.)</i> |

SCHEDA TECNICA/ DATA SHEET

ED.3 27.06.2018

VersaLux

Connettori dati-voce / Data-voice connectors

| | |
|--------------|-----------------------------------------------------------------------------|
| LAN/Ethernet | RJ45 CAT.6 UTP / RJ45 CAT.6A STP <i>RJ45 CAT.6 UTP / RJ45 CAT.6A STP</i> |
| USB | USB 2.0 <i>USB 2.0</i> |
| Video | VGA (15-pin) <i>VGA (15-pin)</i> |
| Audio | Mini-jack 3.5 mm <i>Mini-jack 3.5 mm</i> |
| Audio/Video | HDMI DisplayPort |

Finiture / Finishes

Tappo / *Stopper*



Acciaio lucido
Lucid steel



Acciaio spazzolato
Brushed stainless steel

Profilo / *Profile*



Alluminio anodizzato
Anodized aluminium



Cromo
Chrome

Certificazioni / Approvals



Note/Notes

- Personalizzabile per tipo di prese e connettori data
- Disponibili a richiesta altre finiture
- Uso solo in ambienti interni



ATTENZIONE!!!

- Questo apparecchio deve essere collegato a terra
- L'apparecchio deve essere collegato ad una presa principale correttamente installata e provvista di collegamento a terra in accordo alle norme vigenti.
- Se il prodotto viene montato in zone a rischio di contatto con l'acqua, bisogna applicare del silicone o sigillanti simili sul piano dove appoggia la cornice.

- *It can be customized according to the type of sockets and data connectors*
- *Indoor use only*
- *Other finishes available upon request*



WARNING!!!

- *This appliance must be earthed*
- *This appliance must be connected to a main socket correctly installed and provided with ground connection in accordance with current norms.*
- *If the product is mounted in areas at risk of contact with water, it is necessary to apply silicone or similar sealants on the panel where the frame stands.*

Tutte le dimensioni indicate sono nominali. I disegni e le immagini sono solo a scopo illustrativo. I dettagli del prodotto e le dimensioni sono soggetti a modifiche senza preavviso. **All dimensions quoted are nominal only. Drawings and images are for illustrative purposes only. All product dimensions and specifications are subject to change without notice.**

VersaLux

Dimensioni/Dimensions

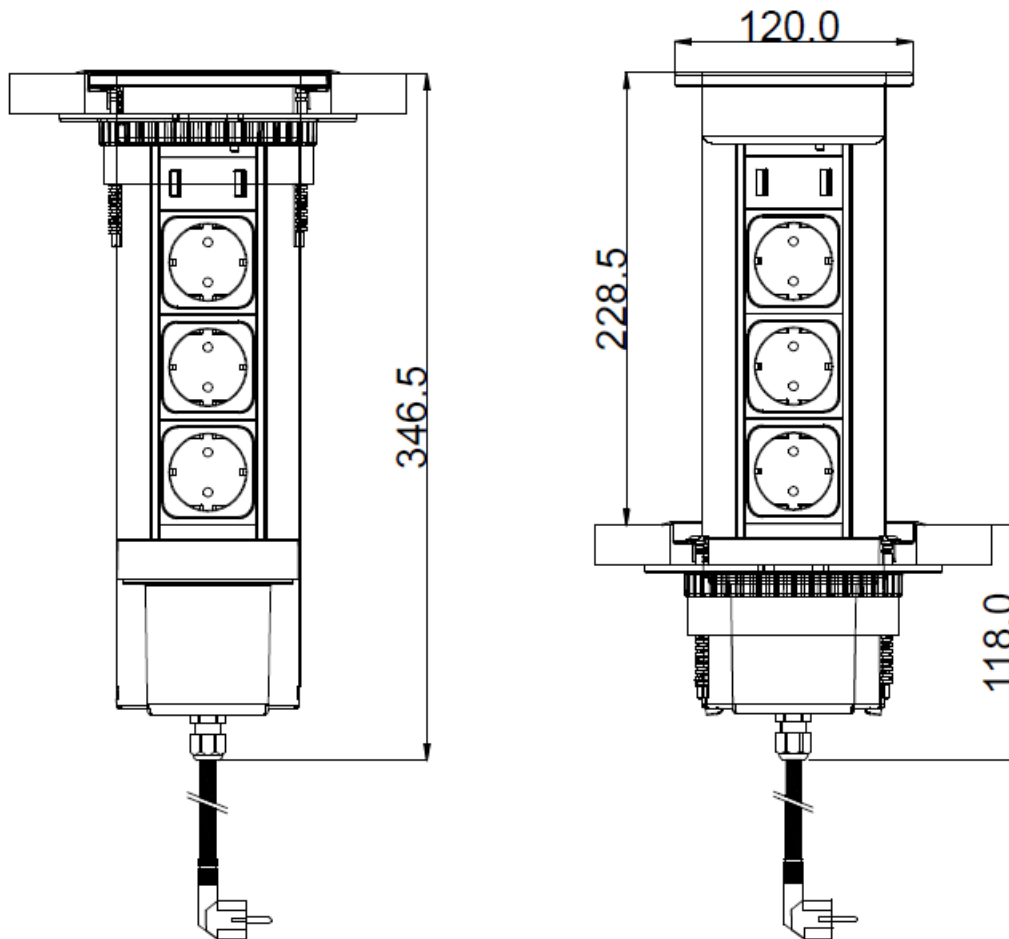

VersaLux

VersaLux con Flangia Filo Piano

VersaLux with Flush Fit Adaptor

FLANGIA PER APPLICAZIONE
FILO PIANO
FLUSH FIT ADAPTER

FORO SU PIANO: DIAM. 124 mm
HOLE ON THE PLANE: DIAM. 124 mm

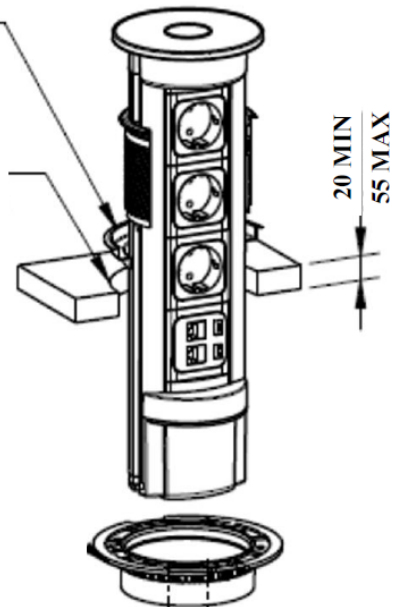

VersaLux senza Flangia Filo Piano

VersaLux Socket without Flush Fit Adaptor

FORO SU PIANO: DIAM.100 (+1.0/-0) mm
HOLE ON THE PLANE: DIAM.100 (+1.0/-0) mm

