

Exit dual 2.0

Passaggio cavi per piani scrivania
Side by side access plate

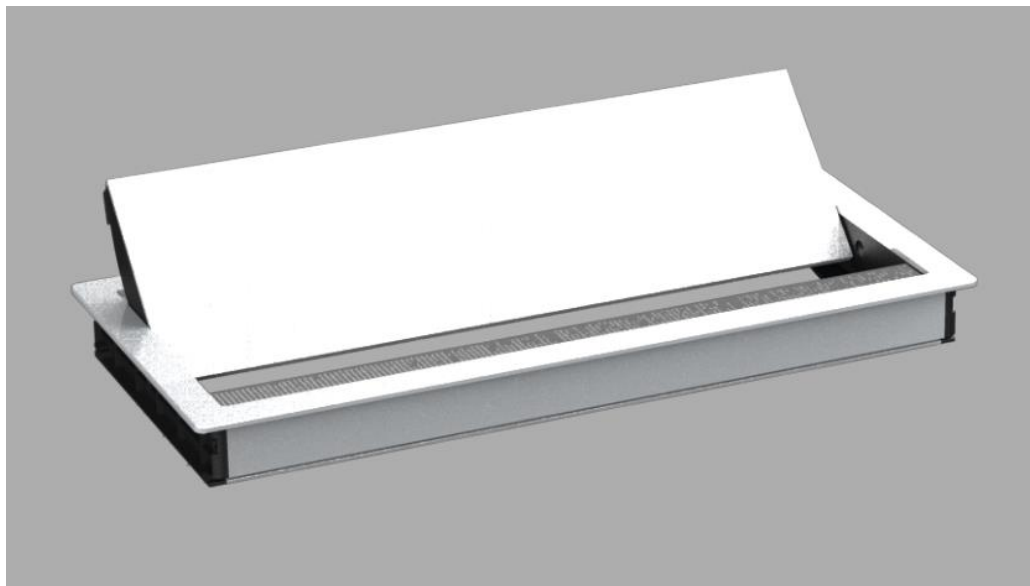

Dati commerciali / Commercial data

Codice prodotto

Product code:

Codice famiglia di prodotto - Valido per tutte le configurazioni





Family product code - Valid for all configurations

Dati tecnici / Technical data

Generale/General

Materiale	Alluminio
<i>Materials</i>	<i>Aluminum</i>

Finiture / Finishes

Corpo <i>Body</i>	Nero <i>Black</i>	
	Bianco <i>White</i>	
	Grigio <i>Grey</i>	
Spazzola <i>Brush</i>	Nera <i>Black</i>	
	Grigio <i>Grey</i>	

Certificazioni / Approvals



A.S.A. Plastici S.r.l | Via Buonarroti, 60 | 20090 Trezzano S/N (MI) Italy | P.IVA IT02526270158
Tel/Phone +39024455894 | Fax +39024450107 | Website: www.asaplastici.it | E-mail: info@asaplastici.it

Documento Riservato – Vietata ogni riproduzione non autorizzata
All rights reserved. Any unauthorized reproduction is strictly prohibited.



Dimensioni / Dimensions

VERSIONI	A	B	L
1	304.5	140.5	316
2	437	140.5	448

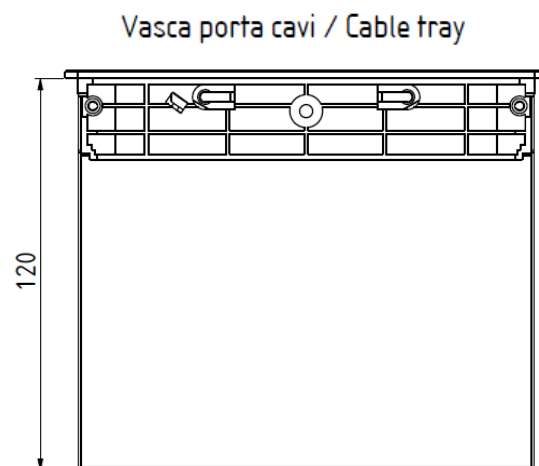
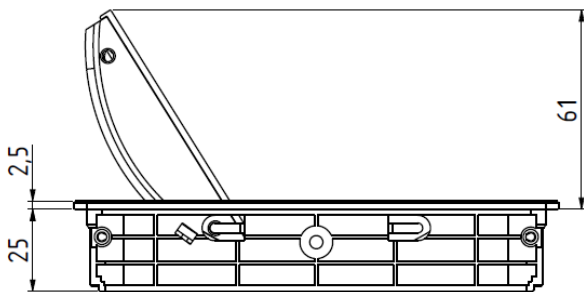
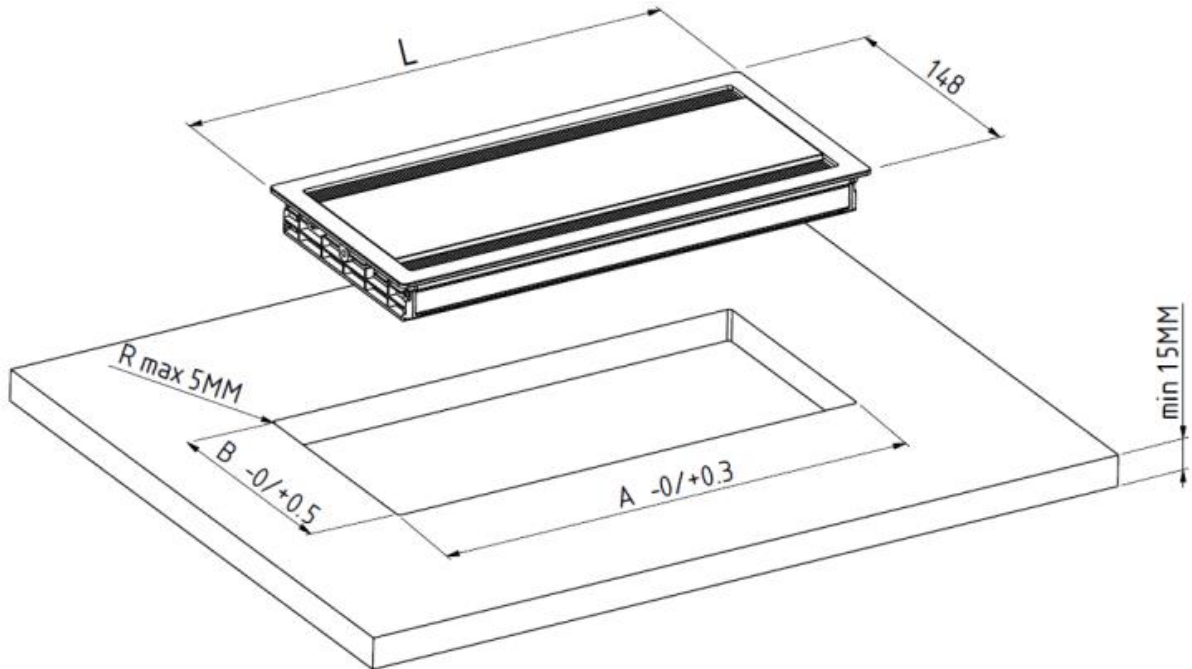

Tutte le dimensioni indicate sono nominali. I disegni e le immagini sono solo a scopo illustrativo. I dettagli del prodotto e le dimensioni sono soggetti a modifiche senza preavviso.

All dimensions quoted are nominal only. Drawings and images are for illustrative purposes only. All product dimensions and specifications are subject to change without notice.