

# VERSAHIT mono combi

Modulo cablato a scomparsa con sportello scorrevole |  
Powerdock with sliding covers

SCHEDA TECNICA | DATA SHEET

ED.06\_05.09.2023

# VERSAHIT mono combi

Modulo cablato a scomparsa con sportello scorrevole |  
Powerdock with sliding covers



## DATI COMMERCIALI | COMMERCIAL DATA

Codice prodotto Product code	060.25	Codice famiglia di prodotto - Valido per tutte le configurazioni Family product code - Valid for all configurations
---------------------------------	--------	--

## DATI TECNICI | TECHNICAL DATA





### GENERALE | GENERAL

Tensione nominale Rated voltage	110 - 250 V ac, 50 Hz	
Corrente nominale Rated current	10 - 16A	
Grado di protezione Degree of protection	IP54	A coperchi chiusi With closed covers
Ambiente di utilizzo Operating environment	Interno Indoor	

## MATERIALI | MATERIALS

Corpo Body	Tecnopolimero autoestinguente Flame retardant polymer
Cornice e sportelli Frame and covers	Zama Zamak
Prese elettriche Electric Sockets	Tecnopolimero autoestinguente Flame retardant polymer







## PRESE ELETTRICHE | ELECTRIC SOCKETS

Tipo Type	B - E - F - G - J, 2P+T, con otturatori (protezione bimbi) B - E - F - G - J, 2P+T, with shutters (child protection)			
	 B	 E	 F	 G
Vtaggio Rated voltage	220 - 250 V ac, 50 Hz	Presse tipo I Socket type	E - F - G - J	
	110 - 125 V ac, 60 Hz	Presse tipo I Socket type	B	
Corrente Rated current	16 A	Presse tipo I Socket type	E - F	
	13 A	Presse tipo I Socket type	G	
	12 A	Presse tipo I Socket type	B	
	10 A	Presse tipo I Socket type	J	
	3400W	Presse tipo I Socket type	E - F	
Carico massimo complessivo Max.load power	2800W	Presse tipo I Socket type	G	
	2200W	Presse tipo I Socket type	J	
	1200W	Presse tipo I Socket type	B	

## PORTE USB DA RICARICA | USB CHARGING PORT

Ingresso Input	100 - 250 Vac 50/60 Hz		
Uscita Output	USB A+C	5V, 2.4A, PMax. 12W (ricarica normale condivisa tra le porte USB-A e USB-C / standard charging shared between USB-A and USB-Cports)	
Compatibilità Compatibility	Tutti smartphone, tablet e altri dispositivi ricaricabili (fotocamere, auricolari, ecc.) All smartphones, tablets and other USB chargeable devices (cameras, headset etc.)		

## FINITURE | FINISHES

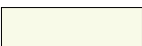
Corpo   Body		Spazzola   Brush	
	Acciaio spazzolato Stainless steel		Bronzo Bronze
	Champagne Champagne		Peltro Pewter
	Oro satinato Matt gold		Nero satinato Matt black
	Bianco opaco RAL 9003 Matt white RAL 9003		Bianco opaco RAL 9010 Matt white RAL 9010



## NOTE | NOTES

- Personalizzabile per tipo di prese.
- Disponibili a richiesta altre finiture.
- Uso solo in ambienti interni.

Significato per la protezione IP 54: a coperchi chiusi, la penetrazione di polveri e liquidi non danneggerà l'apparecchiatura.

Prima cifra caratteristica indica il grado di protezione contro l'accesso a parti pericolose e contro i corpi solidi estranei.

5\* Protetto contro la polvere» protezione totale contro la penetrazione di corpi solidi.

Seconda cifra caratteristica indica il grado di protezione contro l'acqua. 4\* Protezione contro la penetrazione di acqua spruzzata sull'involucro da tutte le direzioni.

\* Il grado di protezione del prodotto è garantito solo a coperchi chiusi.

- Attenzione: Il prodotto è stato studiato per drenare l'acqua che accidentalmente può essere rovesciata sopra (a coperchi chiusi), per questo motivo assicurarsi che il fondo dell'alloggiamento del prodotto sia sempre libero affinché possa fuoriuscire l'acqua presente all'interno.

- Prestare particolare cura nella fase di installazione in quanto il prodotto non è previsto con un vaschetta raccogli acqua quindi non deve essere posizionato nelle zone dove l'acqua drenata sottostante può provocare dei danni.

- Se il prodotto viene montato in zone a rischio di contatto con l'acqua, bisogna applicare del silicone o sigillanti simili sul piano dove appoggia la cornice.

- L'apparecchio deve essere collegato ad una presa principale correttamente installata e provvista di collegamento a terra in accordo alle norme vigenti.

- It can be customized according to the type of sockets.
- Other finishes available upon request.
- Indoor use only.

Meaning for the protection IP54: With closed covers, the access of dust and liquids will not damage the device.

First characteristic numeral indicates the degree of protection against access to hazardous parts and against solid foreign objects.

5\* Protected against dust» Total protection against access of solid foreign objects.

Second characteristic numeral indicates the degree of protection against water.

4\* Protection against ingress of water splashed on the housing from all directions.

\* The IP protection degree is guaranteed only with closed lids

- Warning: The product was designed to drain water that may be accidentally spilled over (when the lids are closed), for this reason make sure that the bottom side of the housing of the product is always free so that it can drain the water inside.

- Pay particular care during installation because the product is not provided with a water collecting tray so should not be placed in areas where the drained water below can cause damages.

- If the product is mounted in areas at risk of contact with water, it is necessary to apply silicone or similar sealants on the panel where the frame stands.

- This appliance must be connected to a main socket correctly installed and provided with ground connection in accordance with current norms.



RAEE - Rifiuti derivanti da Apparecchiature Elettriche ed Elettroniche. Questi prodotti devono essere riciclati in modo adeguato e non devono essere gettati fra i rifiuti domestici o nei rifiuti municipali indifferenziati.

WEEE - Waste of electric and electronic equipment. These products must be recycled properly and should not be disposed as household waste. Disposal in general household waste is prohibited.

Tutte le dimensioni indicate sono nominali. I disegni e le immagini sono solo a scopo illustrativo. I dettagli del prodotto e le dimensioni sono soggetti a modifiche senza preavviso.

All dimensions quoted are nominal only. Drawings and images are for illustrative purposes only. All product dimensions and specifications are subject to change without notice.

DIMENSIONI (mm) | DIMENSIONS (mm)

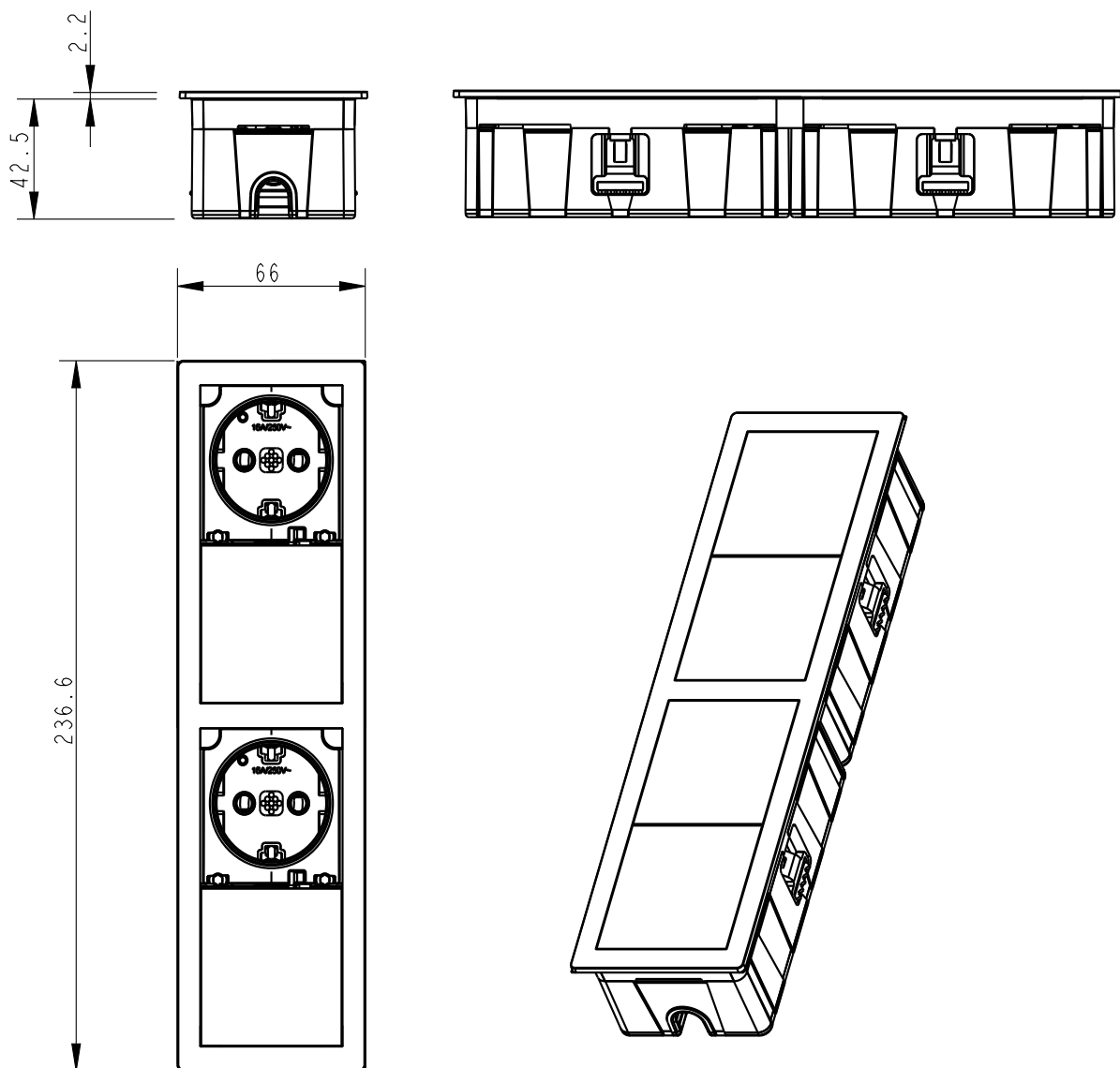

PIANO DI TAGLIO | CUT OUT DIMENSIONS

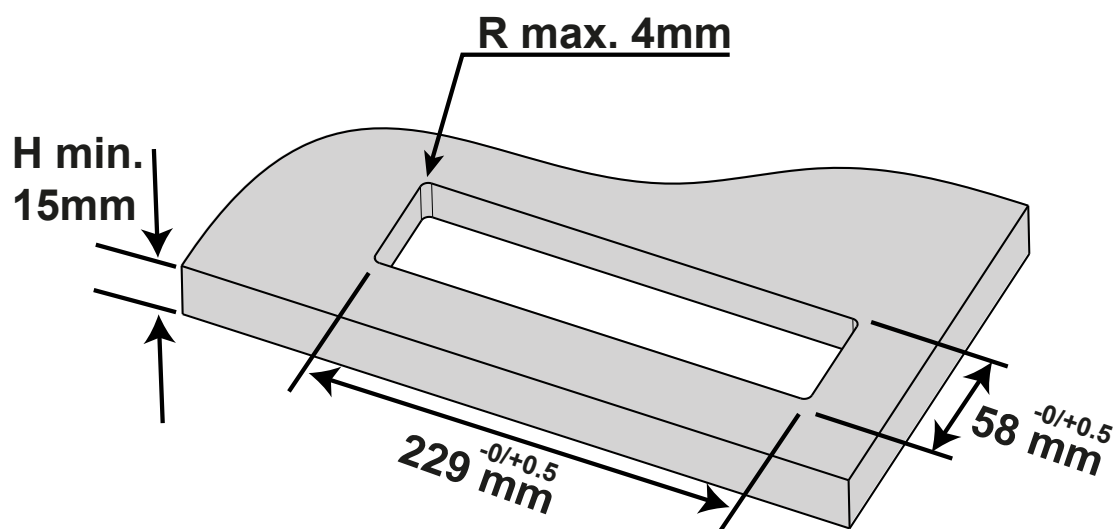

Asa Plastici srl  
via Buonarroti, 58/60  
20090 | Trezzano S/N (MI) | Italy  
Tel/Phone +39 02 4455894 | Fax +39 02 4450107  
web@asaplastici.it  
asaplastici.com



# versahit

modulo cablato a scomparsa con prese indipendenti  
concealed module with independent sockets

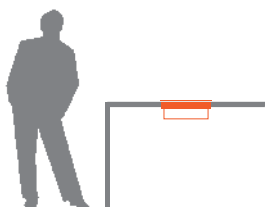

# Versahit mono combi

PRESA   SOCKET						
		F (SCHUKO)		E (FRENCH)		G (UK)

		2 FRUTTI POWER 2 POWER SOCKETS		
CODICE CODE	acciaio spazzolato stainless steel	060.25F.00021	060.25E.00021	060.25G.00021
	PREZZO   PRICE			
	champagne champagne	060.25F.00022	060.25E.00022	060.25G.00022
	PREZZO   PRICE			
	oro satinato gold matt	060.25F.00023	060.25E.00023	060.25G.00023
	PREZZO   PRICE			
	bronzo bronze	060.25F.00024	060.25E.00024	060.25G.00024
	PREZZO   PRICE			
	peilro pewter	060.25F.00025	060.25E.00025	060.25G.00025
	PREZZO   PRICE			
	bianco opaco ral9010 matt white 9010	060.25F.00026	060.25E.00026	060.25G.00026
	PREZZO   PRICE			
	bianco opaco ral9003 matt white 9003	060.25F.00027	060.25E.00027	060.25G.00027
	PREZZO   PRICE			
nero satinato matt black	060.25F.00028	060.25E.00028	060.25G.00028	
PREZZO   PRICE				

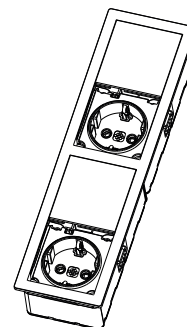

		1 FRUTTO POWER + 1 USB 5V (2 PORTE A+C) 1 POWER SOCKET + 1 USB 5V (2PORTS A+C)		
CODICE CODE	acciaio spazzolato stainless steel	060.25F.00041	060.25E.00039	060.25G.00038
	PREZZO   PRICE			
	champagne champagne	060.25F.00042	060.25E.00040	060.25G.00039
	PREZZO   PRICE			
	oro satinato gold matt	060.25F.00043	060.25E.00041	060.25G.00040
	PREZZO   PRICE			
	bronzo bronze	060.25F.00039	060.25E.00037	060.25G.00037
	PREZZO   PRICE			
	peilro pewter	060.25F.00044	060.25E.00042	060.25G.00041
	PREZZO   PRICE			
	bianco opaco ral9010 matt white 9010	060.25F.00045	060.25E.00043	060.25G.00042
	PREZZO   PRICE			
	bianco opaco ral9003 matt white 9003	060.25F.00046	060.25E.00044	060.25G.00043
	PREZZO   PRICE			
nero satinato matt black	060.25F.00040	060.25E.00038	060.25G.00036	
PREZZO   PRICE				

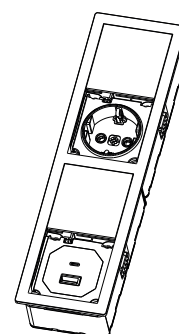

## NOTE | NOTES

DIM. L x H x W 44 x 29 x 35 cm		PESO WEIGHT 7,5 kg	PEZZI PER SCATOLA PCS PER BOX 6	MOQ 6 PZ / PCS	CODICE DOGANALE CUSTOM CODE 85366990
CAVI INCLUSI   CABLES INCLUDED 2 metri / meters	 	CAVO ALIMENTAZIONE CON SPINA SEPARATA POWER CABLE FREE END PLUS SEPARATE PLUG			